

MBRA1060GCT&MBRA1060DCT

10.0AMPS. SCHOTTKY BARRIER RECTIFIERS

FEATURE

- . High current capability
- . Low forward voltage drop
- . Low power loss, high efficiency
- . High surge capability
- . High temperature soldering guaranteed
260°C /10seconds, 0.25"(6.35mm)from case.

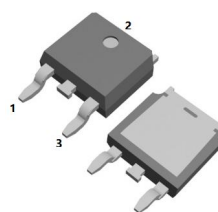

TO-252-2L
MBRA1060GCT

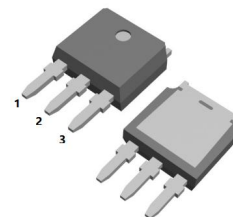

TO-251-3L
MBRA1060DCT

MECHANICAL DATA

- . Case: Molded with UL-94 Class V-0 recognized
Flame Retardant Epoxy
- . Mounting position: any

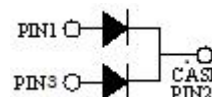

Single phase, half wave, 60Hz,resistive or inductive load.

For capacitive load, derate current by 20%

MAXIMUM RATINGS (T_C=25°C unless otherwise noted)

Parameter	Symbol	MBRA1060GCT&MBRA1060DCT	Units
Maximum Recurrent Peak Reverse Voltage	V_{RRM}	60	V
Maximum RMS Voltage	V_{RMS}	42	V
Maximum DC blocking Voltage	V_{DC}	60	V
Maximum Average Forward Rectified Current <i>Per Leg</i> At T _C =100°C <i>Total device</i>	$I_{F(AV)}$	5.0 10.0	A
Peak Forward Surge Current 8.3ms single half sine-wave superimposed on rated load (JEDEC method) <i>Per Leg</i>	I_{FSM}	100.0	A
Typical Junction Capacitance (Note 1)	C_J	202	pF
Operation Junction Temperature and Storage Temperature	T_J, T_{STG}	-55 to +150	°C

ELECTICAL CHARACTERISTICS-(per leg) (T_A=25°C unless otherwise noted)

Parameter	Symbol	Test conditions	Typ	Max	Units	
Forward voltage drop	V_F	T _J =25°C	I _F =3A	0.61	---	V
			I _F =5A	0.68	0.78	
		T _J =125°C	I _F =3A	0.53	---	
			I _F =5A	0.59	0.69	
Reverse leakage current	I_R	T _J =25°C	V _R =60V	---	100	μA
		T _J =125°C	V _R =60V	---	20	mA

THERMAL CHARACTERISTICS(T_C=25°C unless otherwise noted)

Parameter	Symbol	MBRA1060GCT	MBRA1060DCT	Units
Typical Thermal Resistance (Note 2)	$R_{(JC)}$	6.5	6.5	°C/W

Notes:

1. Measured at 1.0 MHz and applied reverse voltage of 4.0Vdc
2. Thermal Resistance from Junction to Case

RATING AND CHARACTERISTIC CURVE

FIG.1-TYPICAL FORWARD CURRENT DERATING CURVE

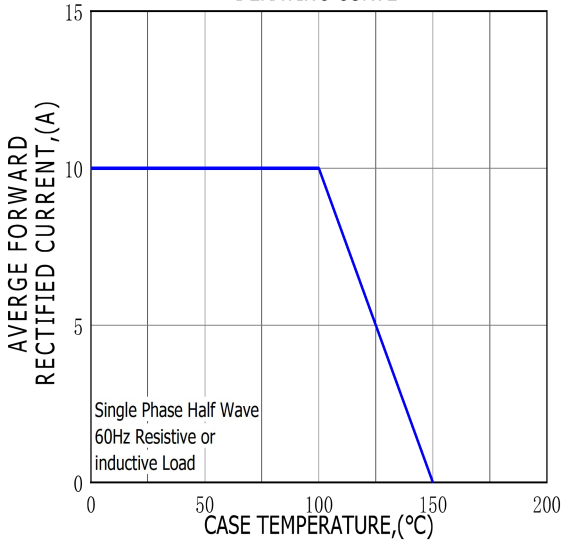

FIG.2-TYPICAL INSTANTANEOUS FORWARD CHARACTERISTICS

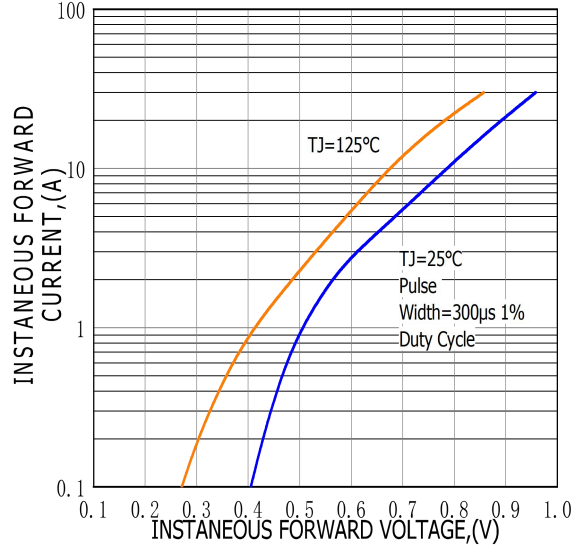

FIG.3-MAXIMUM NON-REPETITIVE FORWARD SURGE CURRENT

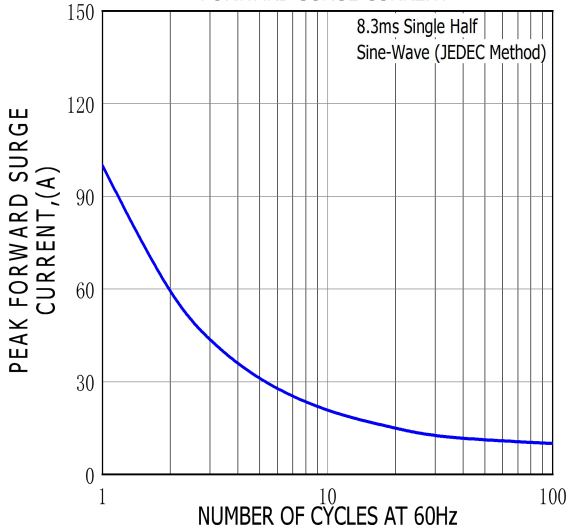
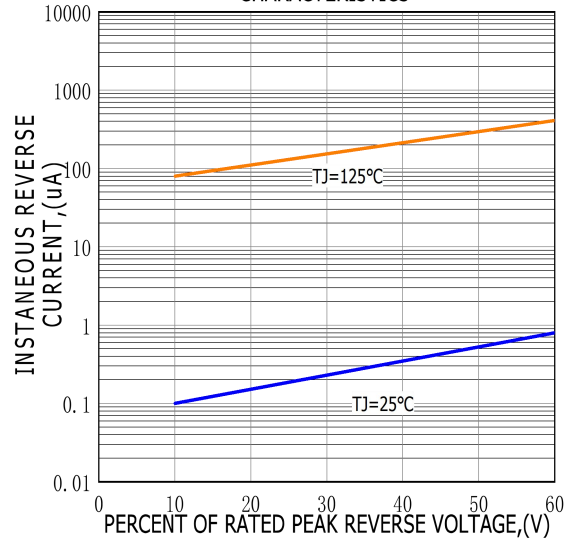
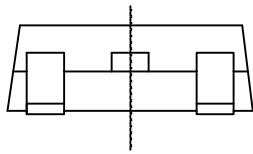
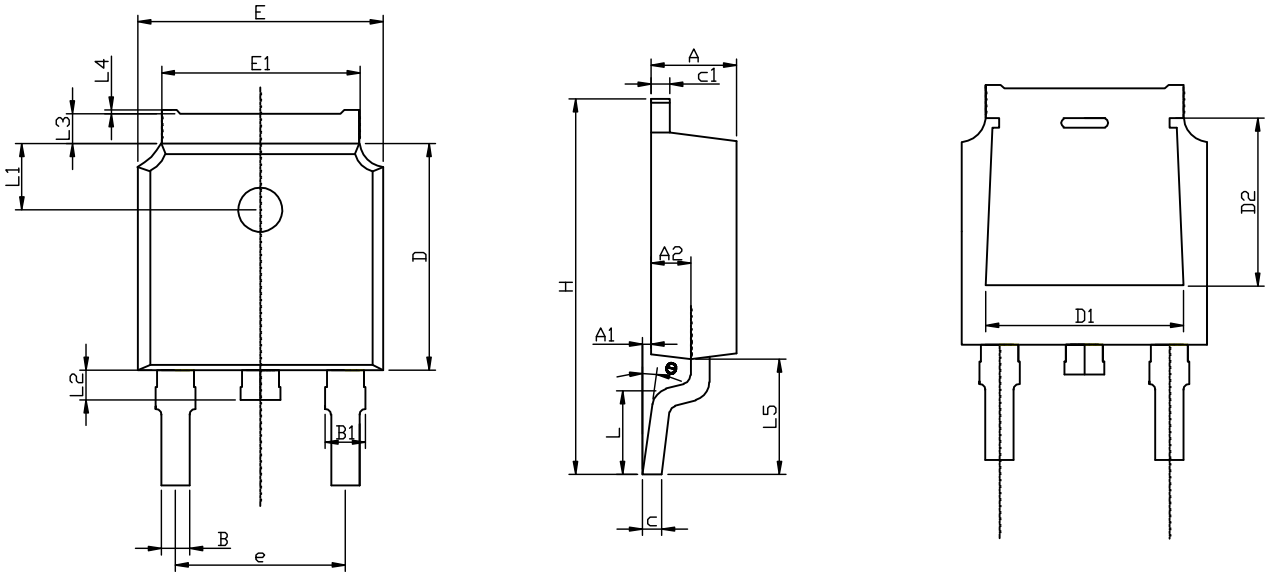

FIG.4-TYPICAL REVERSE CHARACTERISTICS



TO-252-2L PACKAGE OUTLINE



RECOMMENDED LAND PATTERN

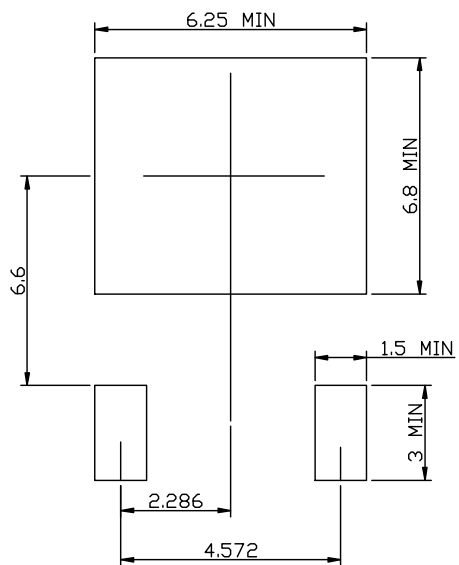

	MIN	NOM	MAX
A	2.15	2.30	2.45
A1	0.05	0.10	0.20
A2	0.91	1.07	1.22
B	0.66	0.76	0.86
B1	0.93	1.08	1.23
C	0.40	0.50	0.60
C1	0.40	0.50	0.60
D	5.95	6.10	6.25
D1	-	4.8REF	-
D2	-	3.8REF	-
E	6.45	6.60	6.75
E1	5.12	5.32	5.52
L		1.65	
L1	1.58	1.78	1.98
L2	0.60	0.80	1.00
L3	0.70	0.85	1.00
L4	0.00	0.05	0.20
L5	2.80	3.10	3.40
H	9.80	10.10	10.40
Θ	0°		8°
e		4.572REF	

UNIT: mm

TO-251-3L PACKAGE OUTLINE

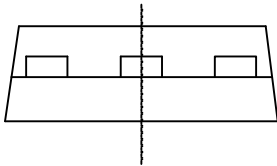
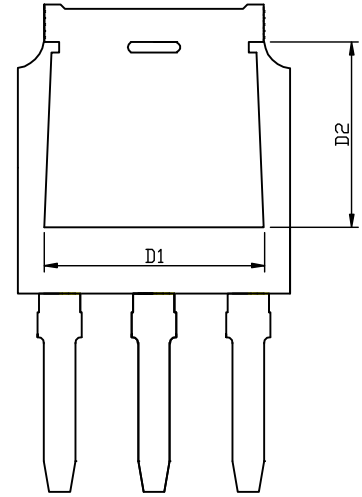
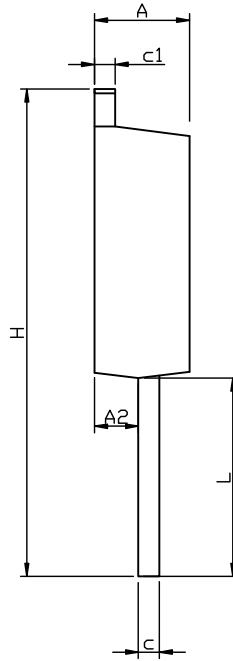
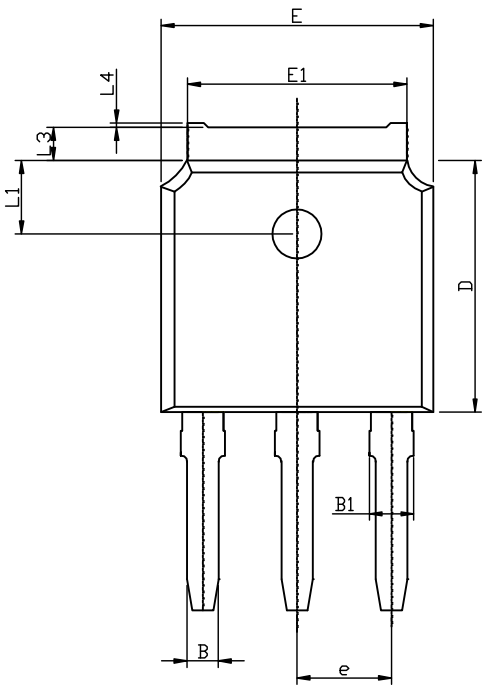

RECOMMENDED LAND PATTERN

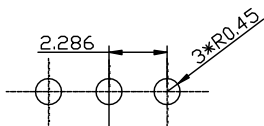

UNIT: mm

	MIN	NOM	MAX
A	2.15	2.30	2.45
A2	0.91	1.07	1.22
B	0.66	0.76	0.86
B1	0.93	1.08	1.23
C	0.40	0.50	0.60
C1	0.40	0.50	0.60
D	5.95	6.10	6.25
D1	-	4.8REF	-
D2	-	3.8REF	-
E	6.45	6.60	6.75
E1	5.12	5.32	5.52
L	4.50	4.80	5.10
L1	1.58	1.78	1.98
L3	0.70	0.85	1.00
L4	0.00	0.05	0.20
H	11.50	11.80	12.10
e		2.286REF	